

## C 型组合式空气阀 C Type Combination Air Valve

C 型是一款高品质组合式空气阀，适用于各种灌溉系统应用场合和工况。具有快速进排气口和自动微量排气口，因此在系统注水时，空气阀能快速排出管道中大量空气；在系统有压状态下，空气阀能持续排出管道中少量空气；在系统排空时，空气阀能吸入大量空气，防止形成负压。

C Type is a high quality combination air valve for a variety of irrigation networks and operating conditions. With its advanced aerodynamic design, double orifice and Surge, it allows efficient release of air pockets from system during pipelines filling, also release a little air continuously during pipeline pressurised and enables large volume air intake to avoid the vacuum formation in the event of network draining.

### 特点 Features:

- 进排气量大 - 采用先进的气体动力学设计，直流道阀体，排气口尺寸大，进排气量比传统空气阀大。
- 密封性好 - 密封工作压力低 (0.2bar/3.0psi)，防止滴漏现象。
- 喷射现象少 - 优异进排气通道结构，减少自动微量排气过程中喷射现象。
- 抗堵性好 - 进排气口带反冲洗结构，不易堆积泥垢，抗堵塞，能适合应用不同水质水源。
- 可靠耐用 - 主体采用优质工程塑料制造，耐化学腐蚀，抗 UV 耐老化；维护频率低，使用寿命长。
- Large Flow: Straight flow body with large diameter automatic orifice, more than usual flow rates.
- Excellent Seal: Prevents leakage under low pressure (0.2bar/3.0psi) by dynamic sealing.
- Less jetting: Reduces jetting water during automatic air release as the excellent intake and exhaust channel structure.
- Anti-clogging: The outlet with backwash structure is not easy to accumulate dirt, which can be suitable for different water quality.
- Reliable and durable: Produced by excellent raw material which is of corrosion, chemical and fertilizer resistant, less maintenance and longer service life.

### 应用 Application:

- 灌溉系统管网：排出灌溉系统中空气，防止水泵下游、主管沿线和主要分支管路在海拔高地方的空气积聚和真空负压形成。
- 灌溉控制首部：防止过滤器，施肥器和主控制阀下游的空气积聚和真空负压形成。
- 田间系统：防止靠近水表和调压阀的地方空气积聚和真空负压形成。
- 安装在泵站：最大限度地提高水泵工作效率及启动能力，并减少停电模式下水压的波动。
- Main Irrigation Networks: Protection against air accumulation and vacuum formation downstream of pumps, along supply lines and at high place in main irrigation networks.
- Irrigation Control Heads: Protection against air accumulation and vacuum formation at filtration, and fertilization stations and downstream of main control valves.
- Infield Systems: Protection against air accumulation and vacuum formation near water meters and automatic regulators.
- Pumping stations: Maximising pumping efficiency, priming capabilities and reducing the possibility of pressure surges during power stop.

产品名称 Product Description	图片 Picture	货号 Item No.	规格 Size	每袋数量 Qty/Bag (Pc)	每箱数量 Qty/Ctn (Pc)	纸箱规格 Ctn Size (Cm)
C 型组合式空气阀 C Type Combination Air Valve		CAV0125B/N	1"BSP/NPT	1	60	54*35*28
		CAV0150B/N	2"BSP/NPT	1	12	54*35*28

### 技术参数 Technical Data:

- 接口规格: 1"BSP/NPT (Dn25), 外螺纹  
2"BSP/NPT (Dn50), 外螺纹
- 工作压力: 0.2-10Bar (3-150psi)
- 爆破压力: 35Bar (500psi)
- 使用温度: 1-60°C
- 主体材料: 加强尼龙
- 密封材料: EPDM
- Size : 1"BSP/NPT ( Dn25) , Male Thread  
2"BSP/NPT (Dn50) , Male Thread
- Working Pressure : 0.2-10Bar ( 3-150psi )
- Burst Pressure: 35Bar (500psi)
- Working Temperature : 1-60°C
- Body Material : Glass Reinforced Nylon
- Seal Material : EPDM

	尺寸 (Size)				重量 N.W.(kg)	排气口规格 Air Orifice Size (mm <sup>2</sup> )	
	DN	Inch	D(mm)	H(mm)		动力式快速进排气口 Kinetic Orifice	微量排气口 Automatic Orifice
	25	1"	100	165	0.5	320	5.4
50	2"	198	248	1.4	1590	12.2	

### 产品结构图 Part List:

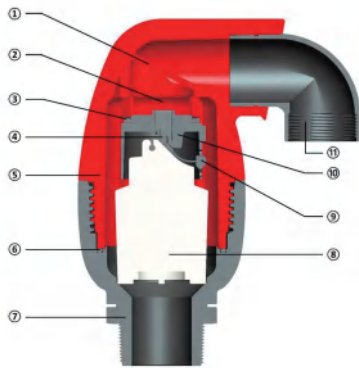

序号 Part	名称	Description
1	防虫网	Insect Screen
2	动力式快速进排气口	Kinetic Orifice
3	低压密封	Dynamic Seal
4	微量排气口	Automatic Orifice
5	阀体	Body
6	O 型圈	O-Ring
7	外螺纹底座	Male Threaded
8	浮球	Float
9	卷链式密封	Peel Seal
10	浮球罩	Kinetic Plug
11	排水弯头	Drainage Elbow

### 进排气流量性能表 Air Flow Performance Charts:

进排气 (系统注水、排空、负压工况)  
Air Relief and Intake (Pipeline Filling,  
Draining and Vacuum Conditions)

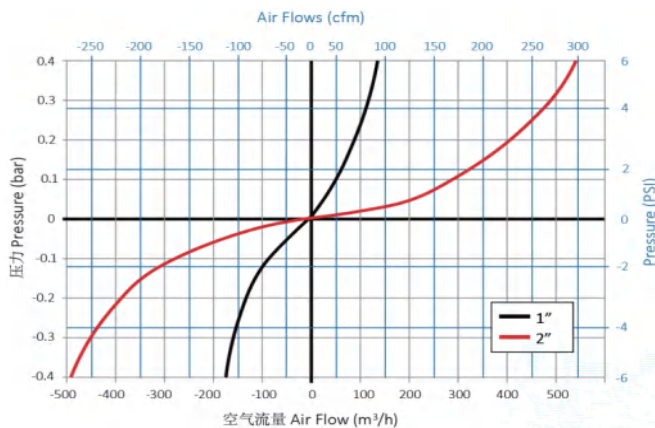

排气 (有压工况)  
Air Release (Pressurized Operation)

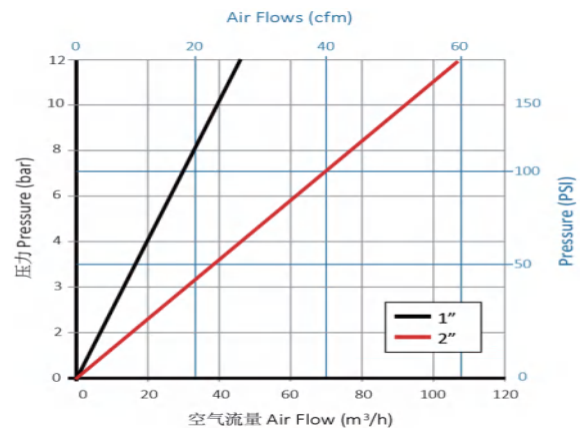

## K 型快速进排气阀 K Type Kinetic Air Valve

K 型是一款动力式快速进排气阀，适用于各种灌溉系统应用场合和工况。本阀门采用符合气体动力学的先进设计，具有优异的快速进排气口，当系统注水时，空气阀能快速排出管道中大量空气，避免空气聚集在系统管道内；在系统排空时，空气阀能吸入大量空气，防止系统管道形成真空负压；同时低压时具有良好的密封性。

K Type is a high quality Kinetic Air Valve for a variety of irrigation networks and operating conditions. With its advanced aerodynamic design, this valve can evacuate large volume air during pipeline filling; enables large volume air intake and provides excellent protection against vacuum formation in the event of network draining. It is also with improved sealing under low pressure conditions.

### 特点 Features:

- 进排气量大 - 采用先进直流通道设计，进排气口尺寸大，进排气量比普通空气阀大。
- 进排气性能好 - 采用整体浮球防吹起设计，避免浮球过早封闭进出排气口，让阀能及时有效地吸入和排出空气。
- 密封性好 - 可在低压力下 (0.1bar/1.5psi) 保持良好的密封性，避免发生漏失现象。
- 性能可靠 - 结构简洁，符合气体动力学，运行可靠，维护频率低。
- 经久耐用 - 主体采用优质工程塑料制造，耐化学腐蚀，抗 UV 耐老化，使用寿命长。
- Large Flow: Straight flow body with large diameter automatic orifice: More than usual flow rates.
- Good intake and exhaust performance: With aerodynamic full-body kinetic shield, it prevents premature closing without disturbing air intake or discharge.
- Excellent Seal: Prevents leakage under low pressure (0.1bar /1.5psi) by dynamic sealing Compact, simple and reliable structure.
- Reliable and durable: Compact, simple and reliable structure whose parts are fully corrosion, chemical and fertilizer resistant Lower maintenance and increased life span.

### 应用 Application:

- 灌溉系统管网：排出灌溉系统中空气，防止水泵下游、沿程输水管道以及管道上下坡位置形成负压。
- 灌溉控制首部：防止过滤器，施肥器处形成负压。
- 田间系统：避免形成负压。
- Main Irrigation Networks: Air relief and vacuum prevention downstream of pumps, along supply lines and at elevations in main irrigation networks.
- Irrigation Control Heads: Air relief and vacuum prevention at filtration and fertilization stations.
- Infield Systems: Prevention of vacuum formation.

产品名称 Product Description	图片 Picture	货号 Item No.	规格 Size	每袋数量 Qty/Bag (Pc)	每箱数量 Qty/Ctn (Pc)	纸箱规格 Ctn Size (Cm)
K 型快速进排气阀 K Type Kinetic Air Valve		KAV0125B/N	1"BSP/NPT	1	70	54*35*28
		KAV0150B/N	2"BSP/NPT	1	36	54*35*28

### 技术参数 Technical Data:

- 接口规格: 1"BSP/NPT (Dn25), 外螺纹  
2"BSP/NPT (Dn50), 内螺纹
- 工作压力: 0.1-10Bar (1.5-150psi)
- 爆破压力: 35Bar (500psi)
- 使用温度: 1-60°C
- 主体材料: 加强尼龙
- 密封材料: EPDM
- Size : 1"BSP/NPT (Dn25), Male Thread  
2"BSP/NPT (Dn50), Female Thread
- Working Pressure : 0.1-10Bar (1.5-150psi)
- Burst Pressure: 35Bar (500psi)
- Working Temperature : 1-60°C
- Body Material : Glass Reinforced Nylon
- Seal Material : EPDM

		尺寸 (Size)		重量	动力式快速进排气口规格
DN	Inch	D (mm)	H (mm)	N.W. (kg)	Kinetic Orifice Size (mm <sup>2</sup> )
25	1"	65	105	0.2	320
50	2"	90	130	0.3	755

### 产品结构图 Part List:

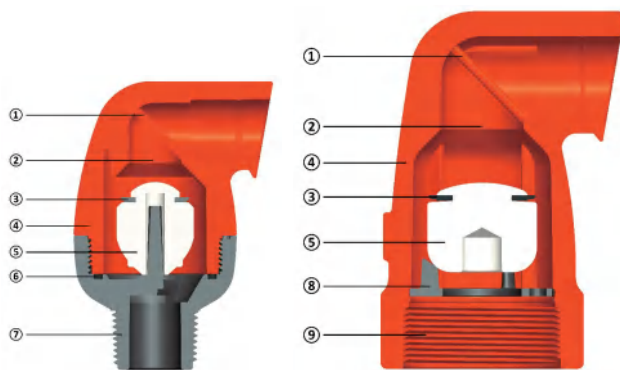

序号 Part	名称	Description
1	防虫网	Insect Screen
2	进排气口	Kinetic Orifice
3	低压密封	Dynamic Seal
4	阀体	Body
5	浮球	Float
6	O 型圈	O-Ring
7	外螺纹底座	Male Threaded
8	支架	Stopping Disc
9	内螺纹	Female Threaded

### 进排气流量性能表 Air Flow Performance Charts:

进排气 (系统注水、排空、负压工况)  
Air Relief and Intake (Pipeline Filling, Draining and Vacuum Conditions)

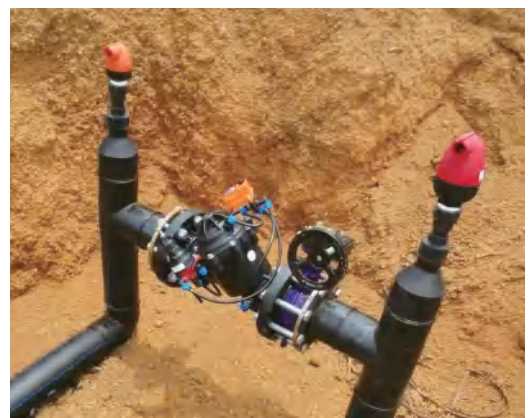
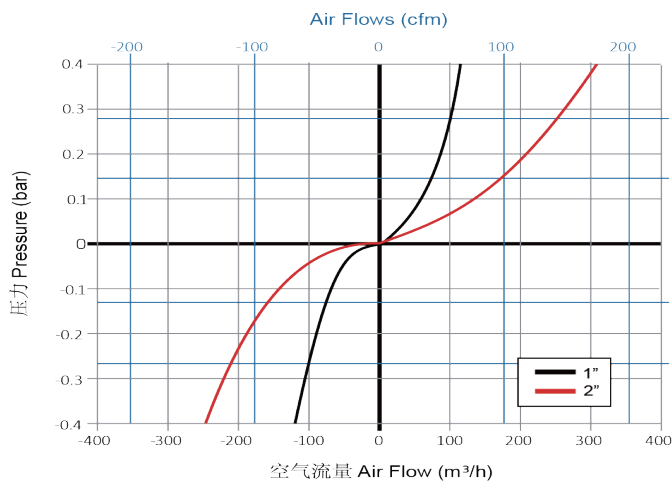

## G 型快速进排气阀 G Type Kinetic Air Valve

G 型是一款高性价比动力式快速进排气阀，可以高效排出或者吸入空气。适用于管道系统、过滤系统及其他灌溉系统工况。当系统注水时，空气阀能快速排出管道中大量空气；在系统排空时，空气阀能吸入大量空气，防止系统管道被真空负压破坏。

G Type is a high cost-effective Kinetic Air Valve which is designed for efficient discharge and intake of air in pipeline systems, filter systems and other locations where confined air could impair the irrigation system's operation. It releases the air at high flow velocity during the initial filling of the system. And intaking large quantities of air to prevent pipelines away from collapse and cavitation damaged when pipe drains.

### 特点 Features:

- 进排气量大 - 大尺寸进排气口为灌溉系统提供最大限度的保护。
- 性能可靠 - 浮球防吹起设计，避免阀门过早关闭。
- 密封性好 - 在低压力下依然保持良好的密封性，避免漏水。
- 经久耐用 - 主体采用优质复合塑料制造，耐化学腐蚀，抗 UV 耐老化，使用寿命长。
- Large Flow: Provide maximum protection of irrigation system by large diameter orifice.
- Reliable performance: The valve remains open until water reaches the float.
- Great Sealing: Offers leak-proof sealing even at a low system pressure.
- Reliable and durable: Lower maintenance and increased life span by made of composite materials with corrosion and UV resistant.

### 应用 Application:

- 灌溉系统管网：排出灌溉系统中空气，防止水泵下游、沿程输水管道以及管道上下坡位置形成负压。
- 灌溉控制首部：防止过滤器，施肥器处形成负压。
- 田间系统：避免形成负压。
- Main Irrigation Networks: Air relief and vacuum prevention downstream of pumps, along supply lines and at elevations in main irrigation networks.
- Irrigation Control Heads: Air relief and vacuum prevention at filtration and fertilization stations.
- Infield Systems: Provention of vacuum formation.

产品名称 Product Description	图片 Picture	货号 Item No.	规格 Size	每袋数量 Qty/Bag (Pc)	每箱数量 Qty/Ctn (Pc)	纸箱规格 Ctn Size (Cm)
G 型快速进排气阀 G Type Kinetic Air Valve		KAV0320B/N	3/4"BSP/NPT	10	150	54*35*28
		KAV0325B/N	1"BSP/NPT	10	150	54*35*28
		KAV0350B/N	2"BSP/NPT	1	70	54*35*28

### 技术参数 Technical Data:

- 接口规格: 3/4"BSP/NPT, 外螺纹  
1"BSP/NPT, 外螺纹  
2"BSP/NPT, 内螺纹
- 工作压力: 0.1-10Bar (1.5-150psi)
- 爆破压力: 20Bar (300psi)
- 使用温度: 1-60°C
- 主体材料: 聚丙烯 PP
- 密封材料: EPDM
- Size : 3/4"BSP/NPT, Male Thread  
1"BSP/NPT, Male Thread  
2"BSP/NPT, Female Thread
- Working Pressure : 0.1-10Bar (1.5-150psi)
- Burst Pressure: 20Bar (300psi)
- Working Temperature : 1-60°C
- Body Material : PP
- Seal Material : EPDM

尺寸 (Size)	重量		进排气口规格		
	DN	Inch	D(mm)	H(mm)	N.W.(kg)
20	3/4"	58	116	71	311
25	1"	58	119	73	311
50	2"	73	123	167	751

### 产品结构图 Part List:

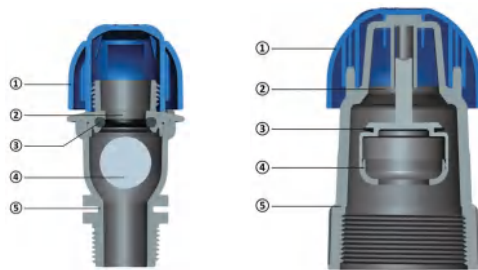

序号 Part	名称	Description
1	防护盖	Cover
2	进排气口	Kinetic Orifice
3	密封圈	Seal
4	浮球	Float
5	阀体	Body

### 进排气流量性能表 Air Flow Performance Charts:

进排气 (系统注水、排空、负压工况)

Air Relief and Intake (Pipeline Filling, Draining and Vacuum Conditions)

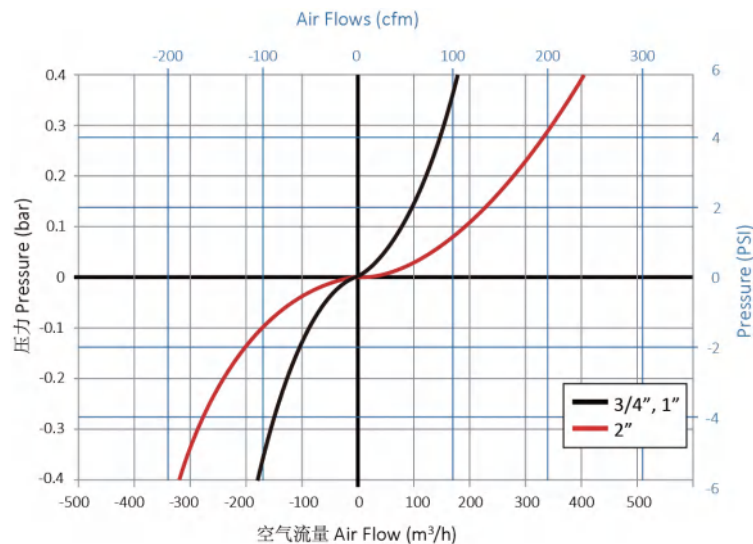

## 空气阀 Air & Vacuum Release Valve

### 特点 Features:

- 进排气空气阀，适用于各种灌溉系统应用，系统注水时，空气阀排出管道中大量空气；系统排空时，空气阀吸入大量空气防止真空负压。
- 阀门采用先进的复合气体动力学设计，具有快速进排气；可避免空气积聚，防止形成负压，低压时具有良好的密封性能。
- Air valve is applied for irrigation system or networks of water supply. It evacuates air during pipeline filling and enables large volume air intake in the event of network draining.
- With its advanced aerodynamic design and kinetic orifice, this valve can provide excellent protection against vacuum formation, with improved sealing under low pressure conditions.

### 应用范围 Application:

- 灌溉系统管网：排出灌溉系统中的空气，避免水泵下游、沿程输水管道以及管道上下坡位置形成负压。
- 灌溉首部：排出空气，防止过滤器、施肥罐处形成负压。
- 灌溉管道高处：排出空气，避免系统高处空气聚集破坏管道。
- Main Irrigation Networks - Air relief and vacuum prevention downstream of pumps, along supply lines and at elevations in main irrigation networks.
- Irrigation Control Heads - Air relief and vacuum prevention at filtration and fertilization stations.
- High part of Irrigation Pipeline System - Air relief, Prevention of pipe broken as for high pressure air.

产品名称 Product Description	图片 Picture	货号 Item No.	规格 Size	每袋数量 Qty/Bag (Pc)	每箱数量 Qty/Ctn (Pc)	纸箱规格 Ctn Size (Cm)	毛重 G.W (Kg)
快速排气阀 Air & Vacuum Release Valve		AV0112B	1/2" BSP	100	2800	54*35*28	21
快速排气阀 Air & Vacuum Release Valve		AV0134B/N	3/4" BSP/NTP	10	200	54*35*28	16
		AV0110B/N	1" BSP/NTP	10	180	54*35*28	18
组合式空气阀 Combination Air Valve		AV0120B/N	3/4" BSP/NTP	1	64	54*35*28	18
		AV0125B/N	1" BSP/NTP	1	64	54*35*28	18
		AV0140B/N	1-1/2" BSP/ NTP	1	64	54*35*28	18
组合式空气阀 Combination Air Valve		AV0150B/N	2" BSP/NTP	1	15	54*35*28	12

技术参数 Technical Data:

货号 Item No.	规格 Model	类型 Valve Type	工作压力范围 Pressure Range ( Bar )	排气量 Air Outtake Flow (m <sup>3</sup> /h)	真空吸入量 Air Intake Flow (m <sup>3</sup> /h)
AV0112	1/2"	Kinetic Air & Vacuum Release Valve	0.3-10	0-35m <sup>3</sup> /h@0-0.4bar	-80-0m <sup>3</sup> /h @-0.4-0bar
AV0134/10	3/4"/1"	Kinetic Air & Vacuum Release Valve	0.3-10	0-50m <sup>3</sup> /h@0.0.35bar	-67-0m <sup>3</sup> /h @-0.35-0bar
AV0120/25/40	3/4"/1"/1-1/2"	Combination Air Valve	0.3-15	0-280m <sup>3</sup> /h@0.0.35bar	-280-0m <sup>3</sup> /h @-0.35-0bar
AV0150	2"	Combination Air Valve	0.3-15	0-360m <sup>3</sup> /h@0.0.35bar	-360-0m <sup>3</sup> /h @-0.35-0bar

进排气流量性能表 Air & Vacuum Flow Rate:

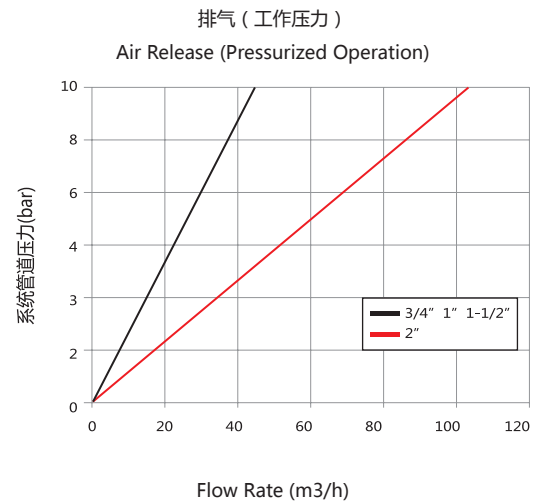
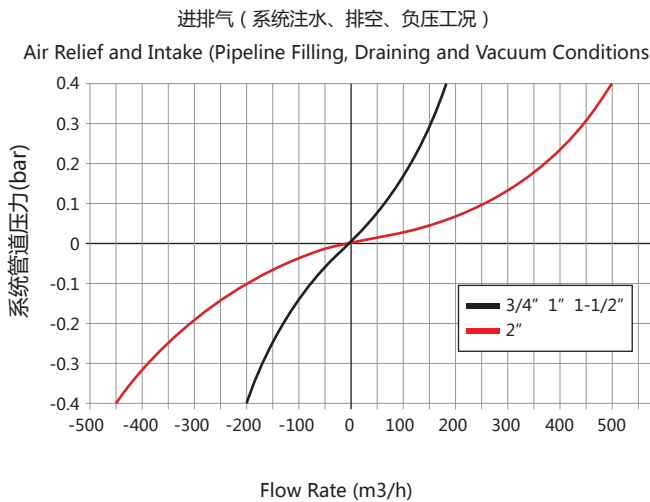

AV0120/25/40/50

排气 (工作压力) Air Release ( Pressurized Operation)

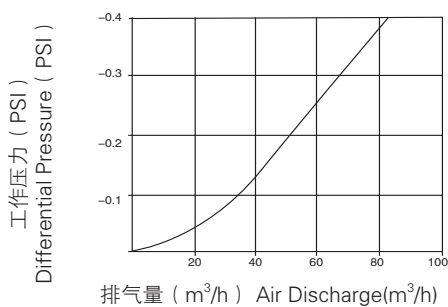

AV0112





## 文丘里注肥器 Venturi Fertilizer Injector

### 特点 Features:

- 主体一次性成型，结构合理。
- 进出水口为外螺纹接头，方便连接。
- 可与注肥器套件配合易于主管道相连接。
- 利用虹吸原理，方便吸入各种液态肥料并注入灌溉管道中，水肥均匀灌溉各种作物。
- Commercial grade one with no moving parts.
- It works by suction and will draw liquid fertilizer out of almost any container you provide.
- Can be plumbed on a bypass for less restriction(the preferred method),or directly into a main water line.
- All sizes have Male Pipe threads on the inlet and outlet, which are easily adapted to hose threads.

### 应用 Application:

- 按作物及灌溉面积挑选相应规格注肥器，太大或太小都不利于有效施肥。
- 如无法确定时，挑选规格小的然后与注肥套件配合与主管道并联安装通过调整阀门控制水量达到注肥目的；如果确定注肥器偏小可通过阀门调小水量通过延长时间达到施肥目的。
- Select the appropriate specification of fertilizer Injector depend on the crop and irrigation area. Too big or too small maybe do nothing.
- If in doubt always choose a smaller size, put it on a bypass assembly which allows you to adjust the flow through the venturi injector and does not restrict the flow as much.

产品名称 Product Description	图片 Picture	货号 Item No.	规格 Size	每袋数量 Qty/Bag (Pc)	每箱数量 Qty/Ctn (Pc)	纸箱规格 Ctn Size (Cm)	毛重 G.W (Kg)
文丘里式注肥器 Venturi Injector		VI0115B/N	1/2" BSP/NPT	10	300	54*35*28	11
		VI0120B/N	3/4" BSP/NPT	10	250	54*35*28	11
		VI0110HB/N	1" BSP/NPT	10	100	54*35*28	12
		VI0132HB/N	1-1/2" BSP/NPT	1	40	54*35*28	9
		VI0234B/N	3/4" BSP/NPT	1	40	54*35*28	5
		VI0250B/N	2" BSP/NPT	1	20	66*31*40	10
过滤吸管套件 Suction Assembly		SA021234	1/2" or 3/4"	1	60	54*35*28	9
		SA021032	1" or 1-1/2"	1	20	54*35*28	9
		SA0120	2"	1	10	54*35*28	10

技术参数 Technical Data:

进水压力 (m)	出水压力 (m)	VI0115B/N		VI0120B/N		VI0234B/N		VI0110H		VI0132H		VI0250B/N	
		流量 L/H	吸入量 L/H	流量 L/H	吸入量 L/H	流量 L/H	吸入量 L/H	流量 L/H	吸入量 L/H	流量 L/H	吸入量 L/H	流量 L/H	吸入量 L/H
14	3	399	67	771	99	493	142	3136	592	4712	564	8172	2075
	7		55		72		70		498		383		858
	8		46		55		44		405		346		-
21	3	462	71	944	107	690	204	3089	578	5575	655	10860	2766
	7		66		107		139		512		567		1897
	10		60		95		85		362		398		1105
	14		24		55		29		122		54		-
28	3	520	66	1024	112	823	204	3595	581	6411	718	12168	2988
	7		65		112		200		581		700		2686
	11		63		107		180		516		605		2116
	14		59		86		114		392		473		1074
	17		46		49		73		268		301		-
35	7	563	68	1129	123	914	211	4059	603	6950	711	13004	2974
	10		65		115		200		608		691		2668
	14		64		110		180		586		619		2063
	17		63		104		107		497		502		1373
	21		55		71		74		369		324		-
	24		32		39		42		213		117		-
42	7	607	66	1215	108	967	209	4178	589	8400	867	14117	3010
	14		65		117		199		576		862		2743
	17		65		110		154		549		780		2368
	21		64		106		110		428		690		1648
	24		61		91		88		311		560		-
	28		40		46		41		97		310		-
49	7	646	70	1283	111	1021	206	4778	608	9120	865	15278	2983
	14		67		112		201		601		863		2945
	21		65		109		156		587		854		2420
	24		64		106		135		556		761		1842
	28		64		94		92		439		750		-
	31		55		70		71		328		604		-
	35		23		42		35		130		471		-
56	7	691	68	1376	114	1097	221	5057	623	9744	876	16272	3031
	14		67		112		211		628		872		2954
	21		66		111		203		601		870		2828
	24		65		109		194		589		852		2453
	28		65		109		157		518		834		1878
	31		65		92		127		455		755		-
	35		60		70		99		329		714		-
	38		43		47		56		229		450		-
70	7	750	69	1466	118	1213	217	5561	356	10860	878	18204	3040
	14		68		110		216		356		872		2970
	21		67		110		212		342		867		3010
	28		67		110		202		338		863		2803
	42		64		75		112		336		852		-
	45		61		51		76		310		325		-
	49		31		16		52		305		186		-